



Thermostatic Douche Bidet Kit



655RN 0515GF

Before you Start



These instructions contain all the necessary installation information for your MX Douche Bidet Kit.
Please read these instructions carefully and check all the components for any sign of damage before starting your installation.



The installation must be carried out by a suitably competent person.



Conveniently situated service valves to the inlet supply must be fitted as an independent method of isolating the unit for maintenance or servicing.



**Please note that you may require 13mm copper pipe and fittings to install the unit.
(NOT SUPPLIED)**



Once the supply pipe work has been fitted flush through to remove any debris form entering the valve and spray head.



Operating Pressures (Bar)

| | Min | Max |
|--------------------------------------|-----|-----|
| Thermostatic Douche Bidet Kit | 0.2 | 5.0 |

Maximum static water pressure for this unit is 10 bar.



Technical Help

Technical Service Line: 0845 505 2211 / 01684 293311 Open Mon–Fri 9am–5pm

Tools and Materials Required **(not supplied)**



Suitable Drill Bits

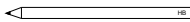

Pencil



Safety Eyewear

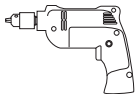

Power Drill



Adjustable Spanner

Safety Notes

Caution: Prior to drilling walls, check that there are no hidden electrical cables or water pipes. When using power tools do not forget to use safety eyewear and clothing. Unplug power tools when not being used.



Parts Supplied - Thermostatic Douche Bidet Kit

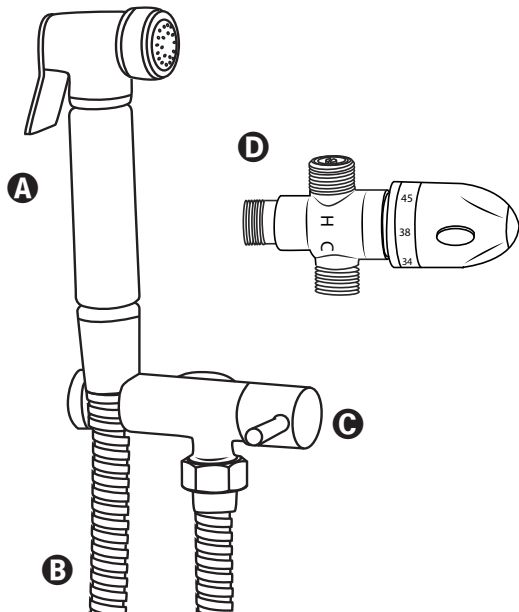

A Spray Head x 1

B Hose x 1

C Valve with built in
bracket x 1

D Thermostatic Mixer
Valve x 1

Installation – Thermostatic Douche Bidet Kit

- 1** Having established the position of the thermostatic mixer valve so it can be connected to both Hot and Cold water supplies. Hot connected to the outlet indicated by **H** and cold connected to the outlet indicated **C**.

Note: Flush pipe work before fitting mixer valve.

Note: Easily accessible service valve should be fitted to both hot and cold supplies for maintenance.

- 2** Fit thermostatic mixer valve (**fig.1**)

Note: Factory set temperature 38°C can be adjusted to suit individual requirements

- 3** The supply pipe work from the mixer valve to the valve with built in bracket can be exposed or concealed and must finish with a suitable 1/2" BSP female fitting (Not supplied)

- 4** Fit valve with built in bracket to 1/2" BSP female fitting (**fig.2**) For concealed option insure shroud is fitted to thread.

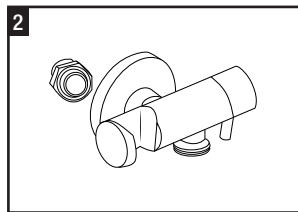
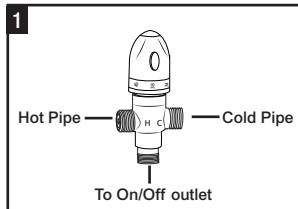

Note! Other tools and materials may be needed depending on the specific site requirements.

Installation – Thermostatic Douche Bidet Kit

- 5** Connecting the hose and spray head. Connect the hexagon nut to the outlet of the valve making sure the sealing washer is in place. **(fig.2)** Screw remaining cone nut to the thread of the spray head, again making sure the sealing washer is fitted. **(fig.3)**

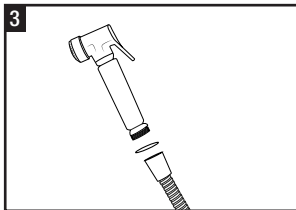
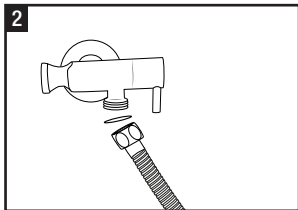

- 6** Commissioning of Unit.

- Turn on water and check for leak.
- Check inlet connection.
- Turn on valve and check hose connections.
- Turn on spray head and check water spray.

Note: Always turn off valve when not in use.



Marleton Cross Limited Trading as **The MX Group**
Alpha Close, Delta Drive, Tewkesbury Industrial Estate, Tewkesbury, Glos. GL20 8JF.
www.mx-group.com email: sales@mx-group.com
655RN_05_15_GF

Product supplied by the MX Group and/or its subsidiaries
Technical Service Line: 0845 505 2211 / 01684 293311 Open Mon–Fri 9am–5pm